

The Ecological Relations between the Herring and the Plankton investigated with the Plankton Indicator.

Part I *by* A. C. Hardy.
 Part II *by* C. E. Lucas.
 Part III *by* G. T. D. Henderson.
 Part IV *by* G. T. D. Henderson, C. E. Lucas,
 and J. H. Fraser.

Department of Zoology and Oceanography, University College, Hull.

Part I. The Object, Plan and Methods of the Investigation.

By

A. C. Hardy, M.A.,

Professor of Zoology and Oceanography, University College, Hull.

With 10 Figures in the Text.

CONTENTS

	PAGE
Introduction	147
Description of the Improved Plankton Indicator	149
The Catching Power of the New Indicator	152
Sampling Methods and their Validity.	154
Extent of Material	157
Methods of Analysis and Correlation	159
The Commercial Application of the Indicator	165
Confirmation of Results	173
Acknowledgements	174
References	176

INTRODUCTION.

A NUMBER of naturalists have expressed their belief that the movements of the adult herring (*Clupea harengus* L.) at certain seasons are governed by the relative abundance or scarcity of their food or other organisms in the plankton.

Goodsir (1843) wrote that the herring follow the swarms of Entomostraca from place to place. Brook (1886) described how the Loch Fyne herrings enter the Loch when the copepod *Calanus finmarchicus* (Günn.) becomes abundant and remain feeding until the copepods have decreased ; Calderwood (1895), also for Loch Fyne, described opaque yellow belts of *Calanus* and stated that fishermen told him that beneath such belts closely packed shoals of herring were usually to be met with. Hensen (1886)

correlated the occurrence of herrings in parts of the Baltic with the density of copepods. Paulsen (1906) in his study of *Calanus finmarchicus* in Icelandic waters shows that its distribution is most irregular and correlated with it the appearance of shoals of herring. Herdman and Riddell (1913) write as follows: "It seems not unlikely that there is a definite connection between oceanic water containing *Calanus* in quantity and shoals of herring in the Hebrides. We have noticed on several occasions that we obtained large hauls of *Calanus* at spots where either the night before or the night after good catches of herring were reported."

Pearcey (1885), who accompanied a herring drifter to the Shetland fisheries, observed that whenever the nets were shot in water rich in phytoplankton (*Rhizosolenia*) the catch of herrings was small. Fishermen have long considered what they call "weedy" or "stinking" water to be unfavourable for fishing. Bullen (1908) had shown that more mackerel were taken where zooplankton predominated and fewer in water where phytoplankton predominated.

The present investigations form a continuation of the researches into the relation of the herring to its animate environment begun by one of the authors when on the staff of the Ministry of Agriculture and Fisheries in 1922. After making a study of the food and feeding habits of the herring (Hardy, 1924) he wrote: "A second aim of the work is to attempt to establish whether the belief . . . that the movements of the herring are in certain seasons influenced by the occurrence of certain plankton organisms is really a fact or not. If it can be shown to be the case, it should be of the greatest importance to the herring industry."

Preliminary experiments were begun in 1922 and 1923 with a torpedo-shaped instrument called the Plankton Indicator. This first model has already been fully described (Hardy, 1926). Essentially it consisted of a cylindrical tube towed through the water and taken below the surface by means of a weight. Towards the tail end the cylinder was hinged to open and allow a gauze disc (60 meshes to the inch) to be inserted for the collection of the plankton. Its construction and working were kept as simple as possible to enable it to be used readily by fishermen for sampling the plankton at the place where they fished, so that the quantity and kind of plankton could later be correlated with the number of herring caught. The method of preserving and returning the discs was the same as that to be described in the present experiments with the improved Indicator. It was hoped that if marked correlations were established between the catches of herring and different kinds of plankton the instrument could be used as an aid to fishing. The fisherman, having learnt to distinguish the differences in the appearance of the discs, would, by frequently sampling the water, be guided away from unprofitable water and into that in which he would be more likely to catch fish.

Only very limited trials were made with this instrument before the author joined the *Discovery* Expedition and the work was for the time being suspended. As far as it went the experiment showed that in the spring and autumn green or pale green discs due to *Phæocystis* or diatoms appeared to indicate water in which fishing was likely to be poor. No definite correlation between the zooplankton and the catches of herring could be made out. It was found however that this type of Indicator, taken below the surface by a weight only, was inefficient, and probably did not reach a sufficient depth to sample the plankton in the region of the herring nets. On his return from the Antarctic and appointment to the University College of Hull he planned (Hardy, 1930) a continuation of the experiment with an improved type of Indicator fitted with diving planes to take it to the required depth. The work was planned to be carried out in both the Scottish and English fisheries as a prelude to a wider scheme of charting the plankton of the North Sea in relation to the fisheries month by month by means of continuous plankton recorders operating on steamship lines. In the summer of 1930 preliminary experiments were begun with the Indicator in Scottish waters and in the following year the Council of the College generously equipped laboratories and provided funds, supported by a grant from H.M. Treasury on the recommendation of the Development Commissioners, and from other bodies (see p. 174), to carry the general plan into effect. Dr. G. T. D. Henderson and Mr. C. E. Lucas, specially appointed under the scheme, took up the analysis and working up of the Plankton Indicator material, the former being mainly responsible for the Scottish material and the latter for the English. The present account of the planning, scope and methods of the investigation forms an introduction to their results which follow in Parts II, III and IV.

DESCRIPTION OF THE IMPROVED PLANKTON INDICATOR.

The new Indicator is considerably smaller than that described in 1926, being only 22 inches in length and $3\frac{1}{2}$ inches in diameter with ends tapering to openings of $1\frac{1}{2}$ inches diameter. It is essentially the same as the former instrument except that it is fitted with a system of vanes and weights which make it dive below the surface to the required depth when towed. The construction of the instrument is shown in Figs. 1, 2, 3 and 4. Figs. 1-3 and the following detailed description (slightly modified) are taken from the British Patent specification No. 369715.* The reference numbers in *italics* refer to the numbering in the figures.

* The instrument is patented in Great Britain and a number of other countries and marketed for commercial use by Messrs. V. D. Ltd., 54 Victoria Street, London, S.W.1, the inventor's royalties on commercial sales being devoted to further research for the benefit of the industry. Investigators who wish to use the instrument for purposes of research may obtain it from Messrs. V. D. Ltd., at a specially reduced rate.

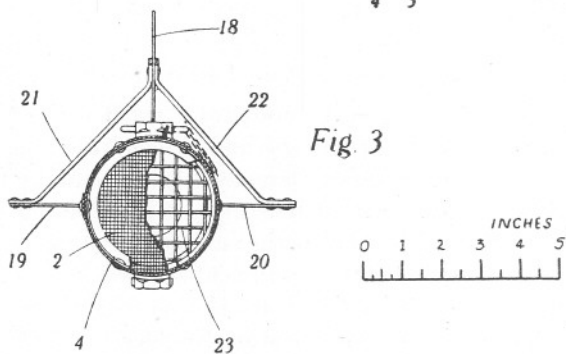
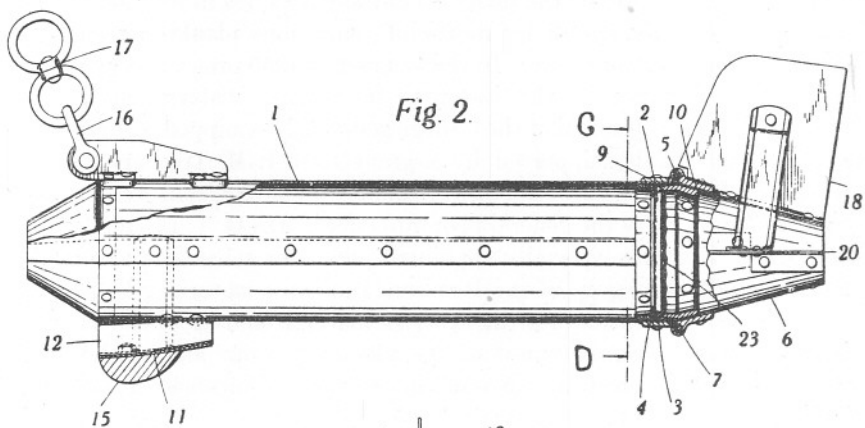
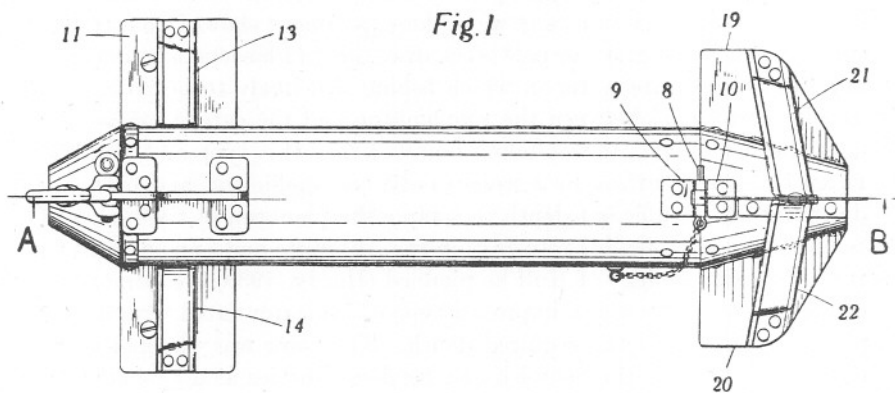

FIGS. 1, 2 and 3.—Showing respectively a plan, a longitudinal and a transverse optical section of the Plankton Indicator. For detailed description and references to letters and numbers see text.

Fig. 1 shows a plan of the instrument. Fig. 2 is a section on the line AB in Fig. 1, and Fig. 3 is a section on the line CD in Fig. 2. It consists of a cylindrical body *I* through the bore of which the water passes as the instrument is towed. A disc *2* of silk gauze* sewn onto a ring† is placed across the bore, the ring abutting against an inwardly projecting flange *4* and being held in position by an annular part *5*. This part *5* is fixed in the tail *6* of the instrument which is hinged at *7* to the cylindrical body *I* so that it can be swung downwards to give access to the disc *2*. When the tail *6* is swung upwards it is locked in position by means of a pin *8* which passes through inter-engaging hinge-like members *9* and *10* fixed respectively on the cylindrical body *I* and tail *6*. The annular part *5* carries cross wires *23* which give support to the disc *2*. The cylindrical body *I* is provided with ends tapering to apertures ($1\frac{1}{2}$ inches diameter)

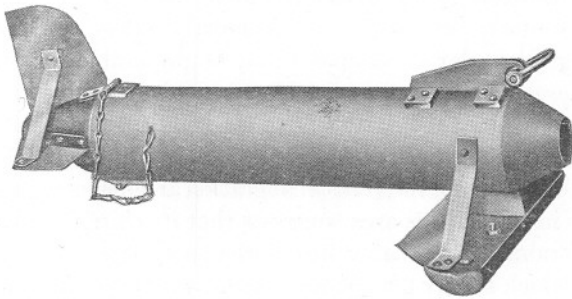

FIG. 4.—The Plankton Indicator.

smaller than the bore of the cylinder, so that the volume of water entering and leaving the instrument is approximately the same as that passing through the disc of fine mesh gauze. The cylindrical body, $3\frac{1}{2}$ inches diameter, is 16 inches long; the tapering fore end and the tail are 2 inches and 4 inches long respectively.

At its forward end the instrument is provided with a vane *11* ($9\frac{1}{2}$ inches by $3\frac{1}{2}$ inches) made horizontal at the front and curving slightly upwards towards the rear; this vane is fixed to the cylindrical body *I* by three struts *12*, *13* and *14* and has on its underside a lead weight *15* ($4\frac{1}{4}$ lb.). On the top of the instrument a shackle *16* and swivel connection *17* are provided for the attachment of the towing line.

The tail is provided with a vertical fin *18* (hind edge 4 inches) and two lateral fins *19* and *20* (the leading edge of each being 2 inches), these

* In the present experiment quadruple strength Swiss silk gauze of 60 meshes to the inch.

† For research purposes it may be convenient to mount the gauze between two concentric rings which fit tightly one inside the other (as the rings used for holding fabric for embroidery); thus numbers of circles of gauze may be used consecutively, being taken out and preserved in tubes of formalin.

being connected to the vertical fin by the bracing members 21 and 22 respectively.

The body and vanes are made of No. 19 gauge galvanized iron. It is important that the vanes should be strong enough to withstand rough usage without being easily bent, but yet not so rigid that they cannot be bent by strong pressure of the hands to make any necessary adjustments to rectify balance.

A much smaller instrument essentially similar to the standard Indicator but only 13 inches long and 1 inch diameter was designed for phytoplankton only; this was used first in the autumn East Anglian fishery in 1934 and is described in Part IV.

THE CATCHING POWER OF THE NEW INDICATOR.

The new Indicator was purposely made smaller than the original model to facilitate handling on commercial vessels. Whilst a larger instrument giving a larger sample would be preferable for work carried out from a research ship, it was considered highly desirable in the present experiment to reduce the instrument to the smallest size which would yet collect a reasonable sample of zooplankton. Gardiner (1933), using this instrument for a study of the vertical migration and distribution of *Calanus finmarchicus* in the Shields area, suggests that its chief disadvantage as a research instrument "probably lies in the small size of the mouth, the diameter of which is only 3.8 cm. and the number of individuals captured even in a twenty-minute haul may be very small." This is true if it is regarded as an instrument for general research, but designed for this particular research of indicating regions of comparatively dense plankton it is shown to give reasonable samples. As many as 8000 *Calanus* have been taken in a one-mile tow, whilst the highest number of *Limacina* (juv. and adult) was close on 100,000. In Table I are shown the analyses of six samples selected to show its catching power of different organisms, each sample representing approximately a mile tow. The largest number recorded for each organism during the course of the experiment is also shown. The average number of *Calanus* per disc taken in the Scottish and Shields fisheries 1931-1933 were 367 and 382 respectively.

The silk of 60 meshes to the inch was chosen as suitable to yield sufficient numbers of zooplankton including *Calanus*, and in addition to retain the larger phytoplankton forms when abundant. If a much wider mesh had been used the phytoplankton, even when dense in the sea, would be largely lost, and if a much finer mesh had been used, then the gauze would become clogged with only a medium concentration of phytoplankton, so that the denser zones, which it is desirable to locate, would be less easily distinguished. A finer mesh too, apart from clogging, would, by reduced filtration, diminish the quantity of the zooplankton obtained.

TABLE I.

SHOWING THE ANALYSES OF SIX INDICATOR SAMPLES, EACH THE RESULT OF APPROXIMATELY 1 MILE TOW, AND THE HIGHEST NUMBER OF A SELECTION OF ORGANISMS RECORDED IN SUCH SAMPLES, TO ILLUSTRATE THE CATCHING POWER OF THE INDICATOR. See p. 152.

Date :	May 31	July 2	May 23	June 14	June 27	Aug. 19	Maximum
Area :	1931	1931	1932	1932	1932	1932	number
	West	East	Shields.	Shields.	Shields.	Shields.	recorded.
	Irish.	Scottish.					
Phytoplankton (selection only)							
<i>Rhizosolenia styliformis</i>		8,000	1,800				28,500
<i>Rhizosolenia stolterfothii</i>		184,000					184,000
<i>Biddulphia sinensis</i>							19,250
<i>Chaetoceros</i> spp.		4,000	21,300				31,200†
Peridinales		1,000				1,300	9,000
<i>Dinophysis</i> spp.						2,000	30,000
<i>Ceratium</i> spp.		22,800	10,200	900	2,400	112,700	300,000
Zooplankton (selection only).							
Medusæ						1	24
<i>Sagitta</i> spp.			17	2	13	11	1,000
Polychæt larvæ							20,400
Tomopteris							8
Podon			4	8			1,250
<i>Evadne</i> spp.		64		120	40		4,000
<i>Calanus finmarchicus</i>	240	40	270	1,176	400	41	8,000
<i>Paracalanus parvus</i> and <i>Pseudocalanus elongatus</i>	1,480		100	96	304	448	2,176
<i>Centropages hamatus</i> and <i>typicus</i>	32	110	12		256	56	1,360
<i>Temora longicornis</i>	16	90	32	56	304	16	3,750
<i>Acartia</i> spp.		10	24	56	144	168	4,200
<i>Oithona</i> spp.	120	10	108	104	88	32	1,160
Total Copepoda	1,888	280	550	1,496	1,576	762	11,000
Amphipoda					1		18
Euphausiacea	24						24
Decapod larvæ							195
<i>Limacina retroversa</i> *	57,000			32		544	96,600
Lamellibranch larvæ		12	4			64	2,700
Cyphonautes larvæ		80	12				750
Actinotrochus larvæ							44
Echinoderm larvæ							1,460
Oikopleura			8	32	16		104
Fish eggs	1				6		128
Fish larvæ and post larvæ					12		12

* See footnote, p. 179.

† Omitting *Ch. socialis*.

It is of interest to note that the mesh used, 60 meshes to the inch, has openings corresponding approximately to those between the gill rakers of the herring. This was only discovered after the choice had been made.

Naturally the small size of the instrument and consequent small quantity of water filtered will prevent a fair sample of the larger and rarer animals being taken. It is possible that by their agility they may be able to escape this smaller instrument; but it should be noted that, employing the paravane principle, the towing wire presents no obstruction to the inlet, which being at the streamlined nose of the instrument cuts the undisturbed water cleanly. The towing wire descending at the end of its catenary curve makes a steep angle with the towing head, and so strikes the water well *above* and *behind* the opening. Quite large young fish, even over 2 inches long, have sometimes been caught whilst mysids, euphausians, decapod larvæ and amphipods are often taken.

SAMPLING METHODS AND THEIR VALIDITY.

To carry out the experiment we sought and received the kind and generous co-operation of drifter skippers, and the commanders of gunboats of the Mine Sweeping and Fishery Protection Flotilla and cruisers of the Fishery Board for Scotland. The former were requested to use the Indicator as in the earlier experiment immediately before shooting their nets, the latter to take samples with the Indicator alongside drifters actually fishing, and afterwards to ascertain their catches from the port of landing. In addition we received the kind help of officers of the Ministry of Agriculture and Fisheries and of the Fishery Board for Scotland, who in different ports collected and returned to us the tins of used discs from the drifters and issued new ones in their place. An acknowledgement of our indebtedness to all these skippers, officers and authorities is given on p. 174.

Each drifter was provided with an Indicator and a length of line marked at 10 fathoms from the Indicator, and the skipper was requested to tow it for 1 mile by the log or for 8 minutes at $7\frac{1}{2}$ knots, immediately before arrival at the place where the nets were to be shot. When towed thus, with the mark at the water surface, the Indicator would swim at a depth of four to five fathoms. After towing, the disc was taken out and placed plankton side downwards on a square of calico provided, wrapped up and held by two rubber bands. It was now dropped into a galvanized iron storage tin containing formalin. When the nets were hauled and the quantity of fish caught ascertained, the catch of herring together with the name and number of the boat, date, position, time of shooting and hauling nets were entered on a printed label provided.* This label was then

* The style of label was similar to that shown in the first Report on trials with the Indicator (Hardy, 1926).

folded up and inserted under the rubber bands securing the corresponding plankton disc. In addition the skippers were invited to add notes on any unusual conditions, state of weather, presence of jelly-fish, etc. that might be of interest. These additional notes have proved to be of value; they are analysed and discussed in a separate paper by Mr. Lucas and Dr. Henderson (1936).

The herring nets are drifting for many hours and the fish may come into the nets early or late after shooting. The plankton is sampled before the nets are shot. Although the ship and nets are drifting, the water sampled may have moved some distance from the nets before the fish are caught; this distance will usually only be small, but if the plankton is very patchy then the nature of the plankton at the position where the fish are actually caught may differ from that at the position of sampling. Further, the mile length over which the Indicator was towed, whilst ending approximately at the point where the drifter begins shooting, may lie at any angle to the line of nets. Again, although fish may be present in large numbers they may not swim into the nets; the presence or absence of fish in the nets is by no means a certain indication that the fish are abundant or scarce in the vicinity. These factors may tend to obscure correlations, but in spite of this, certain correlations have been established by considering a sufficient number of samples.

Whilst the provision of vanes forcing the Indicator down is a great improvement over the simple weight used in the first experiments, the depth at which it fished cannot be regarded as strictly constant. The same will apply to the duration of tow. However willing the fisherman may be to help the scientist, and they have shown remarkable keenness, it is only to be expected that circumstances may cause some small variation in procedure. If the ten-fathom mark on the line provided was not at the surface, or if the speed of the vessel was considerably greater or less than $7\frac{1}{2}$ knots, then the depth of the Indicator would vary accordingly. It is probable that its depth varied between 7 and 10 metres, more usually nearer the lesser depth, and the duration of tow may have varied to some extent above or below the required 8 minutes or one mile by the log. Since we are usually considering comparisons between wide ranges of plankton values these variations will not seriously affect the results.

The time at which the hauls are taken is of importance on account of the differences in vertical distribution of the zooplankton at different times of the day. The samples taken by drifters were all taken immediately before the shooting of the nets. Whilst the time of shooting varies to some extent, depending partly upon the time required to reach the grounds and upon weather conditions, there are indications that the time of shooting from May onwards becomes later and later until August.

when it becomes earlier again. Roughly these average times follow the course of the setting sun through the season, although there appears to be a lag after mid-summer when the sun begins to set earlier. The drifter samples on an average are taken before sunset and bear to one another a reasonably similar relation to light intensity for each area considered.* In the treatment of results only samples from limited areas and limited time periods (usually half-monthly periods) are compared. The differences in the behaviour of organisms, such as *Calanus*, in regard to vertical distribution in different areas and at different seasons have been shown to be great, as witness the results of Russell (1928), Marshall, Nicholls and Orr (1934, also Nicholls, 1933) and Gardiner (1933) for the Plymouth, Clyde and Shields areas respectively. The bearing of vertical migration upon the commercial application of the Indicator is dealt with on p. 171. The fishery cruisers and naval patrol ships aimed at obtaining the samples as near the time of shooting as possible, but a number of samples have been taken at other times between shooting and hauling. In the Shields area such samples do not form an appreciable proportion of the total, but they are more numerous in the Scottish area.

The spatial distribution of samples in different areas and periods varies considerably. At one time the drifters may be fairly evenly scattered over a wide area, or at other times they may be spread widely but in irregular patterns, or again they may be concentrated in a small patch. Naturally a greater range of variation in plankton values and catches of fish may be expected with a wide distribution than with a confined one; but it does not invariably follow. Whilst as many as twenty Indicators have been issued to drifters or patrol ships at one time, usually not more than four or five have been working simultaneously in any one fishery. The curves showing the average catch of herring for the drifters using the Indicator and those for all the vessels in the same fishery are found to be similar, as will be seen in Mr. Lucas's and Dr. Henderson's papers on the Shields and Scottish results which follow. Thus the herring catches of the drifters using the Indicator can be taken on an average to be fairly representative of the whole fleet. Our main object is to find out whether the variations in the plankton are in any way correlated with the variations in the catch of herrings made by the vessels using the Indicator, and if such correlations are found to exist to see to what extent the Plankton Indicator may be an instrument of commercial value. A by-product of this research is the plankton material available for a general ecological study of the plankton of the area concerned; the value of this material is strictly limited by the factors here discussed, particularly the limitations

* In the Southern Bight there is not the same regularity in shooting times, but here in the autumn fishery, where the herring are not feeding, we are only concerned with phytoplankton correlations, the zooplankton being of no importance.

in depth and time (when vertical migration is considered), and the variations in spatial distribution just referred to. Nevertheless, keeping in mind these limitations, some features of the general ecology of the plankton from the different regions can be discussed in regard to the Scottish and English areas in the papers which follow.

Other factors which may tend to obscure correlations existing between the plankton and catches of herring are the variations in the lengths of 'fleets' of nets used and the duration of fishing. The normal variation in the length of the fleet of nets is from 1 to $1\frac{1}{4}$ miles, but occasionally extremes of $\frac{3}{4}$ or $1\frac{1}{2}$ miles may be used (probably these do not occur amongst any of our boats). Since only a few of the boats have supplied us with information regarding the length of the fleet of nets corrections for length have not been made. All the drifters taking part in the experiment were steam and not motor drifters. Whilst the average duration of fishing varies for different boats, the variation in the average catch of these boats bears little or no relation to the time the nets are out, as will be seen in Table II where we are able to compare the average catch of four drifters, termed A, B, C and D* in the Shields fishery over two months in 1932 during which the skippers supplied times of fishing. No doubt if comparison between catch and duration of fishing could be made over very long periods of time some positive correlation must emerge, but, for the shorter periods we are considering, such relations are insignificant because other factors governing the shoaling and swimming of the herring are of much greater importance.

TABLE II.

	Drifter "A"	"B"	"C"	"D"
May 16th-June 15th.				
Av. duration of fishing in hours.	4.5	7.6	9.8	10.5
Av. catch in crans.	3.0	4.2	4.0	4.1
June 16th-July 20th.				
Av. duration of fishing in hours.	4.1	6.3	10.4	9.0
Av. catch in crans.	6.6	3.2	6.4	2.5

EXTENT OF MATERIAL.

During the course of the experiment just over one thousand and four hundred (1406) records of catches of herring with accompanying Indicator samples of plankton were obtained. Of these, 1256 were taken with the

* The drifters are referred to by letters since the owners and skippers of the vessels may not wish their relative catches to be made public.

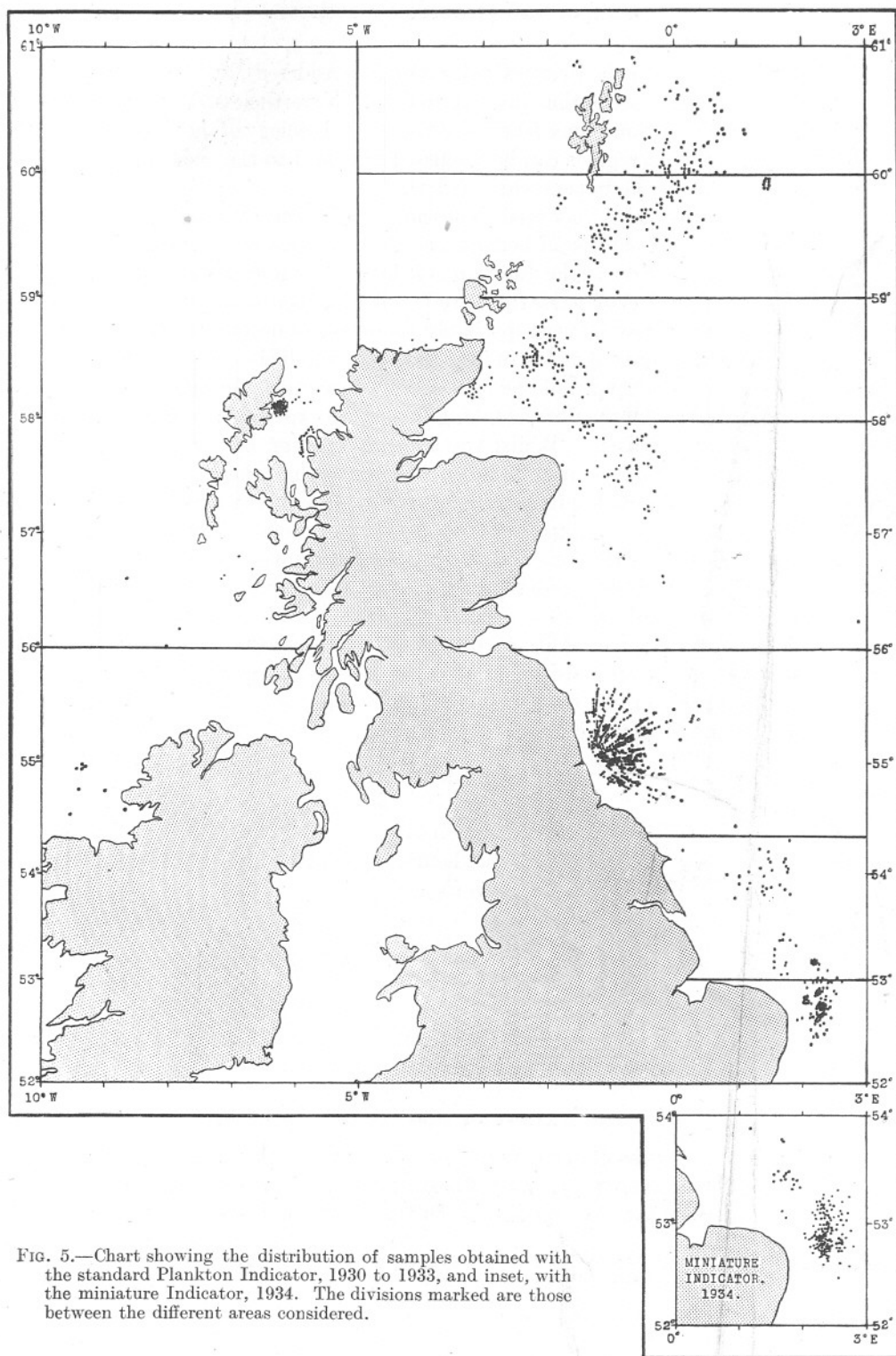

FIG. 5.—Chart showing the distribution of samples obtained with the standard Plankton Indicator, 1930 to 1933, and inset, with the miniature Indicator, 1934. The divisions marked are those between the different areas considered.

standard Indicator in the Scottish and English fisheries (with a few in Irish waters) in 1930-33 and 150 with the miniature phytoplankton Indicator used in the East Anglian fishery of 1934. Not all the analyses of the samples with the standard Indicator have been used in the *Calanus* correlations; some, as explained in the papers which follow, have had to be rejected on account of their isolation in time and space or given only secondary consideration. But all have been useful in relation to the presence or absence of phytoplankton. The general distribution of the samples is indicated in Fig. 5 and in greater detail in the charts in Parts II and III. Altogether forty-three vessels took part in the experiment, of which thirty-five were commercial drifters.

All the samples just referred to and treated in this series of papers are concerned with the drift net fishery. A considerable, not yet sufficient, amount of material has been collected in relation to the practice of herring trawling which is increasing in importance. Here Indicators have been used in the upper layers as well as in a modified form attached to the trawl itself. It is hoped that a paper on their treatment will be published later.

METHODS OF ANALYSIS AND CORRELATION.

Owing to the pressure of water on the disc during towing and the later pressure whilst wrapped in calico in the storage tins awaiting examination, the samples are seldom in so good a condition as are those from tow-nets. Whilst most species, including all crustacea, are identifiable although damaged, some, such as *Oikopleura* spp. and the more delicate larval forms, are very much disintegrated and so liable to be missed in analysis.

The samples obtained in 1930 and 1931 were as far as possible analysed for all species, the whole sample being counted if small or sub-sampled if large. On account of the large number of samples and limited time available, it was decided to confine the analysis in subsequent years to those forms for which there appeared to be any indication of correlation in the results of 1930 and 1931. Thus in 1932 and 1933 only the following organisms were estimated: all phytoplankton, the copepod *Calanus finmarchicus*, total Copepoda, the pteropod *Limacina*, together with records of any of the more unusual forms including fish larvæ and eggs. This restriction of analysis was regrettable but inevitable; the samples, however, have all been preserved, so that if further analysis at a later date appears desirable the material is still available.

The zooplankton correlations with herring catches for 1930 and 1931 appeared to yield two very striking results: a marked negative correlation with the pteropod *Limacina* and a marked positive correlation with the copepod *Calanus finmarchicus*. Thus for the total 513 observations

made in these two years the following table for *Limacina* can be drawn up :

Number of <i>Limacina</i> on disc.	Number of Observations.	Average catch of herring in crans.*
0	201	13.6
1-99	147	10.9
100-249	38	9.6
250-499	33	9.0
500-999	34	3.6
1,000 and over	60 (59)†	4.6 (2.9)†

This result may be further expressed thus :

With 0-99 Limacina the av. catch is 12.5 crans (348 observations)
 ,, 100+ ,, ,, ,, ,, 6.3 ,, (165 ,,)

A similar negative correlation was found in each of the separate sub-areas, except the East Anglian autumn fishery. A particularly marked falling off in catch was noted when the number of *Limacina* exceeded 500. For this reason in making the *Calanus* correlations the examples associated with over 500 *Limacina* were at first omitted, giving the following result for the Scottish fisheries only :

Number of <i>Calanus</i> on discs.	Number of Observations.	Average catch of herring in crans.
0	18	3.2
1-99	135	5.1
100-249	24	7.3
250-499	16	12.9
500-999	15	14.8
1,000 and over	15	22.0

Again this result may be further expressed thus :

With 0-99 Calanus the av. catch is 4.8 crans (153 observations)
 ,, 100+ ,, ,, ,, ,, 13.3 ,, (70 ,,)

or split into the two years

1930

With 0-99 Calanus the av. catch is 5.2 crans (29 observations)
 ,, 100+ ,, ,, ,, ,, 28.6 ,, (23 ,,)

1931

With 0-99 Calanus the av. catch is 3.9 crans (112 observations)
 ,, 100+ ,, ,, ,, ,, 5.9 ,, (48 ,,)

* A cran is a commercial measure of herring by volume. It may be taken on an average to equal approximately 1000 fish, but the numbers may vary considerably for different sizes of fish.

† Excluding a single catch of 102 crans in the autumn East Anglian fishery.

Again in each of the separate Scottish areas* where a reasonable number of trials were made a positive *Calanus* correlation was found.

Attempts were first made to correlate the total Copepoda with herring catches, and positive correlations were found if we adopted a system of weighting the different species of copepods approximately according to their relative mass (a suggestion by Mr. Lucas similar to that independently developed by Gunther, 1934). But it was found that *Calanus*, having so great a mass compared with other forms, overweighted all other species together, so that such total copepod correlations were almost equivalent to *Calanus* correlations.

As the work progressed into 1932 and 1933 it was found that both the ranges of *Calanus* numbers and the catches of herring varied greatly from area to area and at different times of the year. Let us suppose that A and B are two widely separated fishing areas. Whilst it is found that there is usually a correlation between the higher catches of herring and higher *Calanus* samples in each fishing area, it does not follow that if the average number of *Calanus* in fishery A is greater than in fishery B, that the average catch of herring in A will be higher than that in B. Whilst, as we shall see, the movements of the herring within limited areas appear to be correlated with the relative abundance of its food, *Calanus*, within that area, it does not follow that the ratio of the numbers of herring taken in two separated fisheries will bear a relation to the ratio of the numbers of *Calanus* in the two fisheries. Again in any one fishery the average number of *Calanus* may be greater earlier in the season than later on, but it does not always follow that the herring will be more abundant earlier in the season than later and *vice versa*, yet in *any one part* of the season more herring may be found, on an average, where there are more *Calanus*.

Thus it became necessary to treat the results from different fishing areas separately, and to divide the material collected in each area into short-time periods. The boundaries of the areas (Fig. 5) will be defined in Parts II and III; the time periods chosen were half-months.

As already explained, at first we related the associated catches of herring to the *Calanus* numbers below and above 100, or to a scale, as shown in the table on p. 160. But it was soon found that in one area the majority of samples might contain more than 100 *Calanus* whilst in another area (or in the same area at a different time) only a few samples would contain more than 100 *Calanus*.

A new system of correlation was sought, which would have a closer significance in all areas and in all seasons, and which would enable one the better to weigh up the possible commercial value of the correlations.

* In the Shields area in 1931 there was a progressive change from a positive correlation to a negative one as the season advanced; this is discussed in Part II.

Each series of samples considered is now arranged in ascending order of Calanus numbers and the series divided into halves ; one half containing all the samples of lower Calanus value and the other half all those of higher Calanus value. The associated catches of herring are also entered in the table. The average catch of herring relating to the two halves is now estimated. Two examples will illustrate the system adopted ; these are shown in Table III and Table IV. If the number of samples in a given series is odd, the catch of herring corresponding with the middle Calanus value is halved and one half shown on each side of the table, as in the example in Table IV.

TABLE III.

CALANUS-HERRING TABLE FOR THE EASTERN SCOTTISH AREA 59°-60° N,
JULY 16TH-AUGUST 1ST, 1932.

Poorer Calanus water.		Richer Calanus water.	
Calanus numbers.	Herring in crans.	Calanus numbers.	Herring in crans.
1 ..	0.0	1420 ..	0.0
1 ..	24.0	480 ..	19.0
20 ..	20.0	332 ..	10.75
25 ..	4.75	330 ..	59.5
40 ..	0.0	280 ..	63.0
42 ..	4.5	245 ..	37.5
68 ..	0.75	204 ..	61.0
88 ..	72.0	180 ..	9.5
96 ..	30.0	165 ..	2.0
101 ..	1.0	125 ..	47.0
105 ..	0.0	120 ..	36.0
<hr/>		<hr/>	
Totals :	587 157.0	3881	345.25
Averages :	53 14.27	353	31.39

Grand total catch : 502.25 crans for 22 landings.

If all the catches had been made in water of the richer Calanus values the expected (theoretical) total catch would have been 690.5 crans, i.e. a theoretical gain of 188.25 crans over the actual total catch obtained when fishing at random. This may be expressed as a (theoretical) gain of 37.5%.

The differences in the ranges of Calanus values and the catches of herring in the examples chosen is seen to be great, illustrating the unsuitability of adopting a uniform scale of Calanus values. The method adopted enables one to compare the commercial value of the instrument in different areas, where the numbers of herring and Calanus differ considerably. These results have been obtained by drifters not using

the instrument to find the most suitable water (except where stated in the Shields 1933 season), but simply sampling the state of the plankton where they happened to shoot their nets in the ordinary course of fishing.

TABLE IV.

CALANUS-HERRING TABLE FOR THE SHIELDS FISHERY, JULY 1-15, 1933.

Poorer Calanus water.		Richer Calanus water.		
Calanus numbers.	Herring in crans.	Calanus numbers.	Herring in crans.	
65 ..	20.0	2800 ..	31.0	
96 ..	16.0	2520 ..	23.0	
140 ..	2.0	2480 ..	12.0	
150 ..	3.0	2000 ..	5.5	
170 ..	35.0	1920 ..	10.0	
355 ..	7.0	1745 ..	1.0	
390 ..	4.0	1440 ..	1.0	
400 ..	15.0	1280 ..	70.0	
565 ..	1.0	1200 ..	3.0	
585 ..	3.0	1120 ..	12.0	
645 ..	39.0	1080 ..	60.0	
800 ..	6.0	810 ..	6.0	
	(800 Calanus . . . 6.0 crans half shown on each side)			
(400) ..	3.0	(400) ..	3.0	
<hr/>		<hr/>		
Totals	4761	154.0	20795	237.5
Averages	381 ^{12½}	12.3 ^{12½}	1664 ^{12½}	19.0 ^{12½}

Grand total catch : 391.5 crans for 25 landings.

If all the catches had been made in water of the richer Calanus values the expected (theoretical) total catch would have been 475 crans, i.e. a theoretical gain of 83.5 crans over the actual total catch obtained when fishing at random. This may be expressed as a (theoretical) gain of 21.3%.

We may suppose that by using the indicator to find water rich in Calanus the drifters could make nearly all their shots in water having a Calanus value at least as high as that which they actually got in the *higher half* of their trials when sampling at random, and sometimes they should be able to get into water of higher Calanus values than any so obtained. In each series we have worked out the theoretically expected catch if all the catches had been in water of higher Calanus value and compared it with

the actual total catch, expressing the theoretical gain (or loss in some instances) as a percentage of the actual total catch. These estimated percentage gains (or losses) have been used as a measure of the correlation between the herring and Calanus throughout. Only series containing ten or more samples have been considered when arriving at conclusions regarding correlation. In the Scottish fishery secondary series of six to ten samples are tabulated but used only in general support of primary series results. Owing to the fortuitous nature of the fishing and the often small number of samples in each series taken, the actual percentage gain of any one series by itself is of little significance as a measure of the herring-Calanus correlation; and so the commercial efficiency of the instrument must be based upon a consideration of all the different area-period results in the Scottish fisheries and in the Shields fisheries. Since the conditions differ so widely in the different areas—i.e. the average numbers of herring being caught (and the differences in price of fish in different areas)—the commercial value of the instrument must be measured by taking the *average of the percentage gains or losses*. It appears that under these particular circumstances the averaging of the percentage gains or losses is the only means of obtaining an approximate conception of the commercial value of the instrument. To consider the actual total numbers of herring landed for all the right- and left-hand columns of the tables of the different areas, and estimate the total percentage gain would give a very distorted result, for, as seen, the average number of herrings varies greatly in different areas and also the number of samples in the different series varies widely. The figures for some area-periods would be unduly weighted by the larger number of samples in these area-periods than in others. Further, as already pointed out, in considering the commercial value of the instrument the considerable variation in prices in different areas and seasons is of importance. That the *average of the percentage gains or losses* is a figure of real value as an indication of the efficiency of the indicator is shown in the following way. If, in the Shields fishery where the number of samples per series is larger than in the Scottish fishery, we divide the Calanus values for all series into the lower quarters and the higher three-quarters, and again into the lower three-quarters and higher quarters instead of into lower and higher halves and work out the average of the percentage gains or losses in the same way as for the halves, we get figures which show a regular progressive gain to the fisherman who fished exclusively in water of the higher three-quarters, the higher half, or the higher quarter of Calanus values: this is described by Mr. Lucas on p. 213 in Part II which follows.

In the Shields fishery, in addition to estimating the average gain which may be expected for all boats fishing in the water of higher Calanus values, it has been possible to work out separate estimates for each of the individual

drifters taking part in the experiment. Each vessel shows a substantial estimated average gain.

In investigating the *Limacina*-herring correlations it was also desirable to treat the material in small areas and short-time periods to avoid the overlapping of varying ranges of concentration. In dealing with *Limacina* in this way the marked negative correlation of 1930 and 1931 indicated on p. 160 was still evident, but at Shields in 1932 this negative correlation was not always maintained, the tendency being towards a positive one

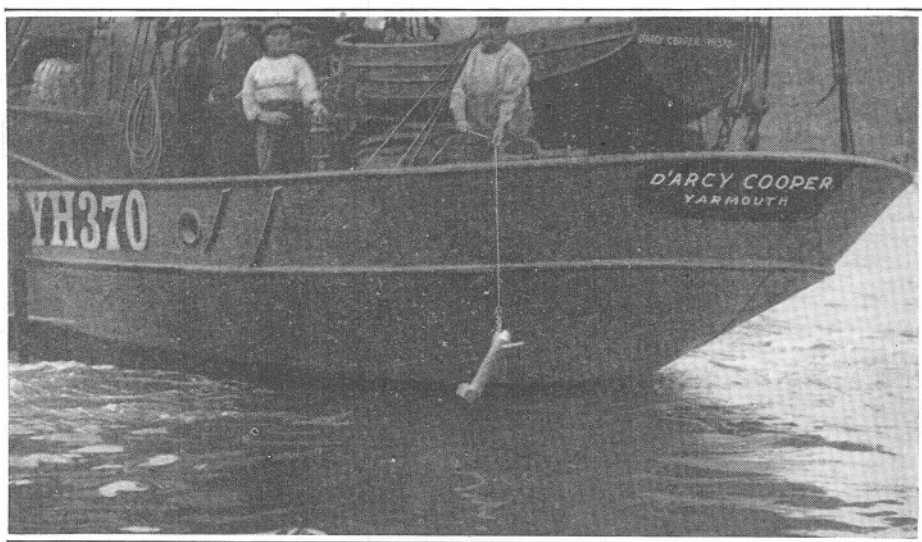

FIG. 6.—The Plankton Indicator in use on a drifter.

although not constant. In 1933 the tendency was again negative. We are thus unable yet to come to a definite conclusion regarding the relation of *Limacina* to the herring; the matter is discussed in Parts II and III.

The phytoplankton correlations for both Scottish and English waters, including the special survey in the autumn East Anglian fishery of 1934 with the miniature indicator, are dealt with together in Part IV by Dr. Henderson, Mr. Lucas and Mr. Fraser. Here for each area the average catch associated with discs coloured green or greenish brown by phytoplankton is directly compared with the average catch associated with those not so coloured. A marked negative correlation is established.

THE COMMERCIAL APPLICATION OF THE INDICATOR.

As a result of the analysis and treatment of the data collected with the Plankton Indicator, described in detail by my colleagues Dr. Henderson,

Mr. Lucas and Mr. Fraser in the papers which follow, two important commercial applications of the instrument have been established.

When the Indicator yields a disc coloured green or greenish brown (due to abundance of phytoplankton) the catch of fish to be expected in such water will be low in comparison with that which may be expected in water yielding a disc not so coloured. All the fisherman has to do in applying this principle is to sample the water from time to time with the Indicator as he seeks his fishing position and steam out of any such areas as give a disc which can be seen at a glance to be coloured green or greenish brown.



FIG. 7.—Fishermen examining the Indicator disc for phytoplankton signs.

Fishermen using the indicator commercially are provided with colour charts for reference. Fig. 6 shows an Indicator being used from a drifter and Fig. 7 a disc being examined for coloration. This indication will be particularly valuable in the spring, early summer, and autumn fisheries when dense phytoplankton concentration may be met with. In the great autumn fishery off East Anglia it has been shown to be particularly important and a special miniature Indicator has been designed for use in this area where the zooplankton correlations are not important and where the concentration of the fleet in a small area renders the standard Indicator less easily used. This miniature Indicator is described on p. 283 in Part IV. Reference has already been made to the traditional belief amongst herring fishermen that what they call "weedy" or "stinking" water is bad for fishing and such conditions have been shown to be due to an abundance

of phytoplankton (Pearcey, 1885; Bullen, 1908; and Hardy, 1923). Whilst occasionally such water may be detected by the fishermen by a discoloration of the water itself, more usually it is only after they have fished that they can detect it by a slimy feeling and the smell of the nets. In our sampling of the East Anglian fishery in the Autumn of 1934 vessels fished in water giving a green indication on 42 out of 150 occasions. Samples were obtained from October 7th to November 20th; throughout this time there were both areas which did and areas which did not yield green discs; on all but few occasions the catches associated with the former

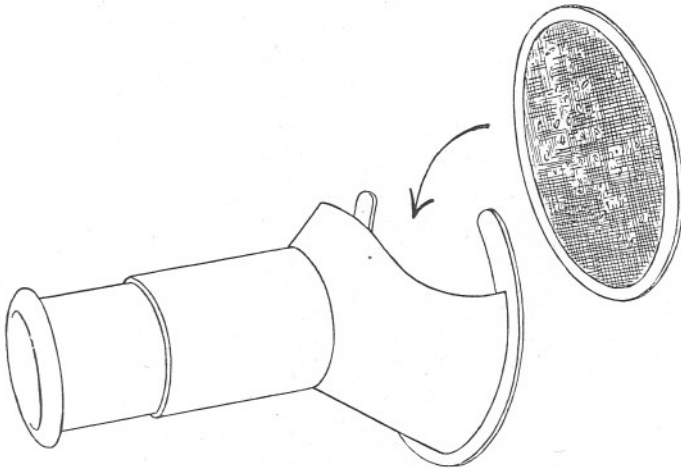

FIG. 8.—The lens holder used for examining the disc for *Calanus* indications.

were considerably lower than those associated with the latter. (See Part IV p. 288).

The other important commercial result is that concerned with the positive correlation found between the herring and its important food organism, the copepod *Calanus*, in the summer fisheries in both English and Scottish waters and also confirmed in the Icelandic fisheries by Fridriksson (see p. 173). By avoiding the water which is poorer in *Calanus* and fishing in that which is the richer in *Calanus* an average gain in catch of 18.3% over that obtained by fishing at random is estimated for the Scottish and Shields fishery together for all periods 1931-33; or omitting the incomplete 1931 year at Shields: 23.0%. The standard errors for the results from the Shields and Scottish fisheries have been calculated and are given in Parts II and III (pp. 209 and 253).

The examples given in Tables III and IV, and in the histograms in Parts II and III will show that herrings are not always taken in larger numbers where there is more *Calanus*. Good catches may be taken in poor *Calanus*

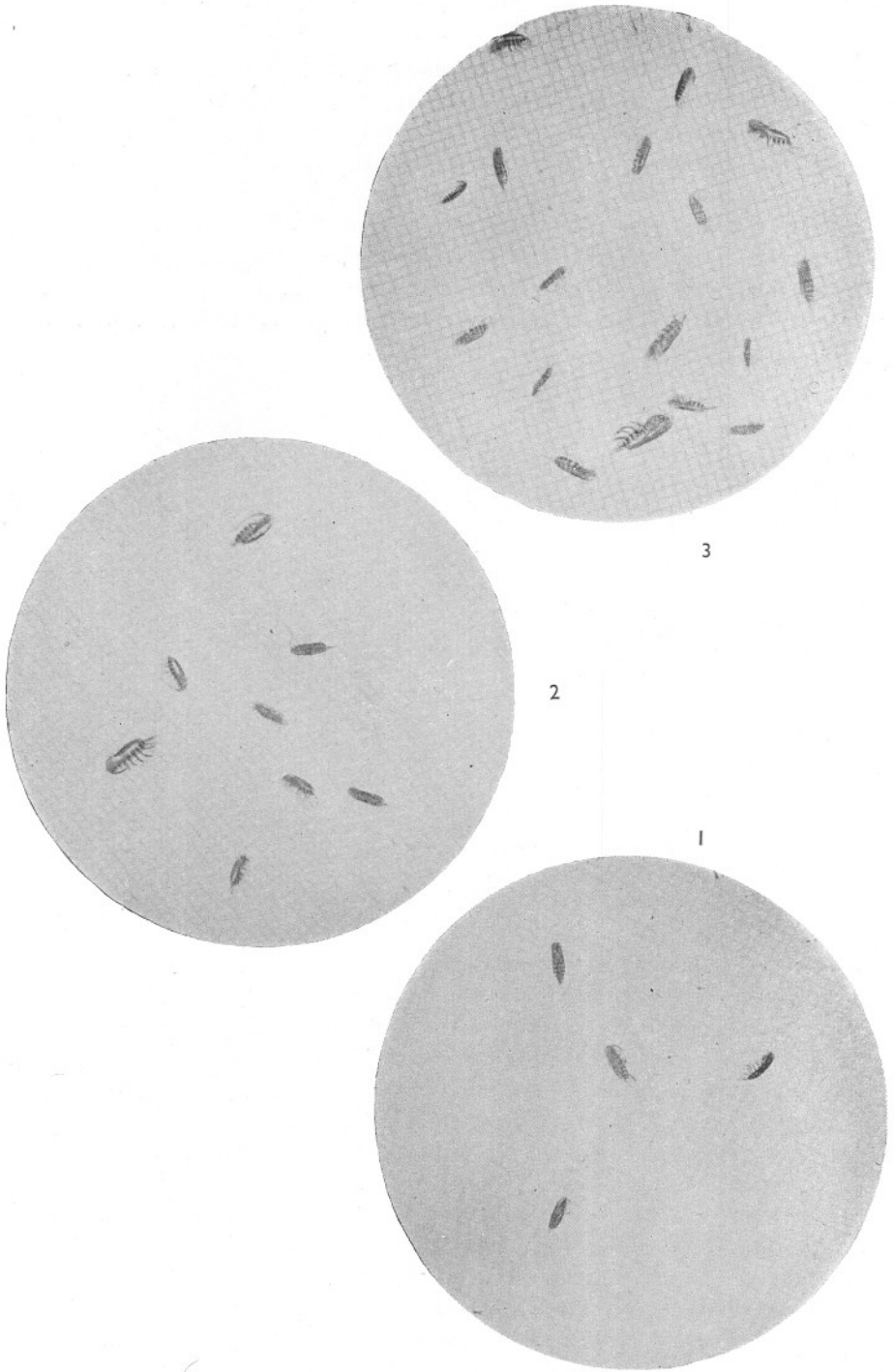
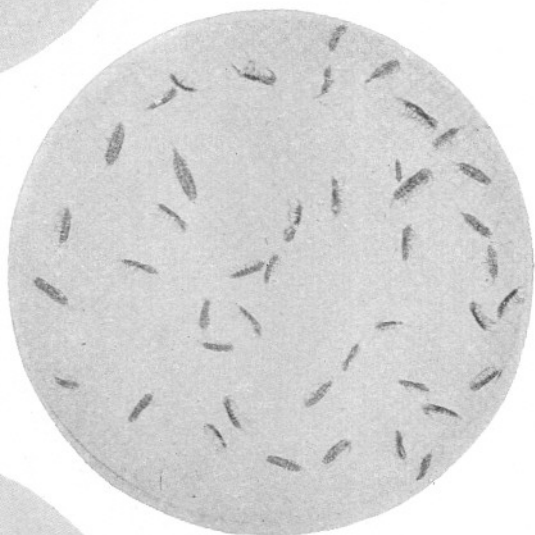

FIG. 9.—Photographic chart, provided with the Indicator for commercial use, showing variations in *Calanus* numbers as seen on the discs through the examination lens. Photographs by J. H. Fraser.



4



5

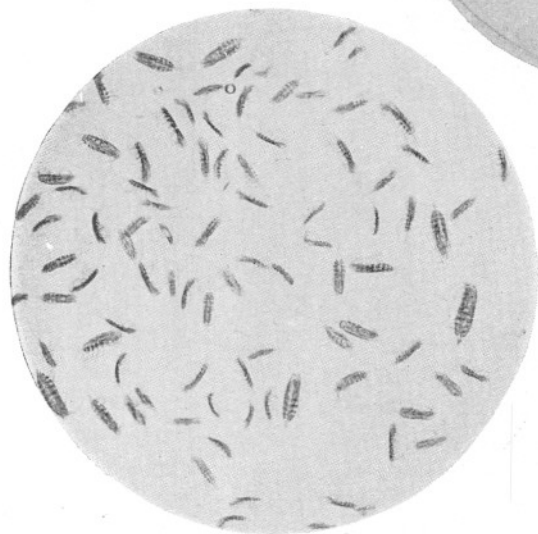

6

FIG 9.—*contl.*

water and poor catches in rich *Calanus* water. But if the instrument is used systematically throughout a season to find the richer *Calanus* water then on an average more herring will be taken than if simply fishing at random. Whilst over some periods a boat may actually lose by following this principle, in the end it should have made a marked gain. For all the individual vessels that have been followed through periods varying from 20 to 156 voyages we have been able to demonstrate that had they fished in the richer *Calanus* water they should all have got substantial gains.

In planning this work it was first thought that if such positive food

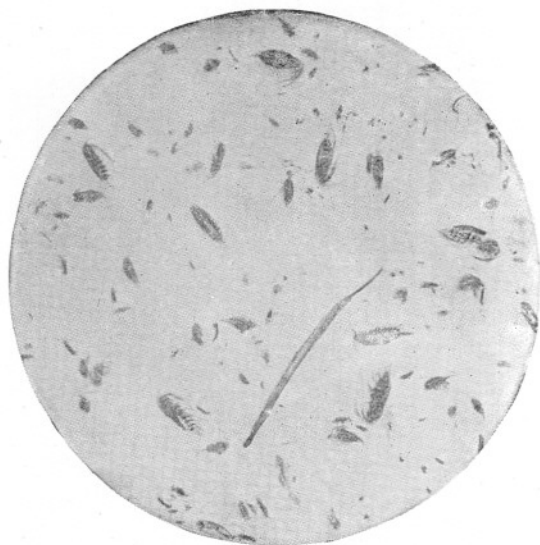

FIG. 10.—Photograph provided with the Indicator for commercial use showing *Calanus* with other plankton forms as seen on the disc through the examination lens. Photograph by J. H. Fraser.

correlations were obtained it would be possible to use a simple colour indication, as in the case of the phytoplankton, in that a quantity of copepods on the disc would give it a pinkish tint. In practice it has been found that the colour of *Calanus* varies very much, sometimes it is almost colourless, and other copepods, not useful as indications, may give a pink coloration. At times too Echinoderm larvæ have been found to colour the discs a brick red. *Calanus* far exceeds all the other Copepods in size and can readily be recognised through a simple lens. For the commercial application of the *Calanus* indications, a simple lens holder, Fig. 8, is provided, into which the disc can be dropped and held up to the light. The fishermen are provided with photographic charts showing the appearance of varying numbers of *Calanus*, Fig. 9, as well as photo-

graphs of *Calanus* as it might appear on the disc mixed with other plankton, Fig. 10. A sample disc with actual *Calanus* preserved between sealed sheets of celluloid is also provided for demonstration. The fisherman very soon learns to recognise its form. On steaming out to the fishing grounds he would take a sample with the Indicator every few miles, towing it each time for a mile by the log without stopping the ship. A small hand reel has been designed to be fixed to the side of the ship to make light work of hauling in the Indicator. At each sampling he will take out the disc and examine it in the lens holder. He will note how the *Calanus* abundance compares with the scale of photographs provided and the position from which the sample was taken. He is supplied with a number of discs (which may be washed and used again) so that he can keep them on one side for reference when he comes to decide on his position for fishing. Thus after taking perhaps six samples over the proposed fishing grounds he will return to fish at the point where the greatest number of *Calanus* was obtained. As Mr. Lucas shows on p. 214, the skipper who takes more trouble (and uses a little more fuel) in trying to find out the richer *Calanus* water is likely to gain a higher reward.

We must now consider the possible influence of the diurnal vertical movements of the *Calanus* on the application of this principle. It is well known that *Calanus* usually tends to move from the lower to the upper layers of water as darkness approaches. The Indicator is designed so that it swims at a depth of 7 to 10 metres from the surface.* Even at this depth some increase in the number of *Calanus* may be expected as time advances towards sunset and darkness. If, for example, in the process of searching, the fisherman's samples have yielded in turn moderate *Calanus*, few *Calanus*, many, very many, few, moderate and he returned to the position which yielded "very many" this should still be the richest position since it can be expected that at all the positions the *Calanus* would be increased by a proportional amount through vertical migration. Only in the exceptional circumstance of the *Calanus* being quite evenly distributed is he likely to experience a gradually increasing quantity of *Calanus*, through the influence of vertical migration, as he steams over the ground as evening approaches; if this was the case, then such an even distribution of *Calanus* in itself would nullify the operation of the principle for the herrings might be expected equally at any point. Our results show that such an even distribution of *Calanus* is hardly ever met with. At times, no doubt, the vertical migration of the *Calanus* may upset the application of the principle; but we believe they will be rare.

During the summer fishing at Shields in 1933 some of the skippers were actually using the Indicator to find the more profitable positions

* It takes up this position when a mark on the towing line, 10 fathoms from the Indicator, is at the surface of the water.

for fishing. Two of these skippers have published accounts of the working of the instrument and it may be of interest to quote from them since they show exactly how it may be used with advantage.

The following extracts are taken from an account by Mr. Ronald Balls, master of the S.D. *Violet and Rose*, YH 757, in *The Fishing News* of February 24th, 1934.

"Calanus is very easily recognised on the disc, and any boats that could do most of their fishing in water containing it could certainly expect a considerable increase in their catches. . . .

First of all, it is most important that the Indicator should be used as consistently as possible over at least a whole summer season for a real test of its usefulness, because, although there are cases where when good feed is found an excellent catch results, this is not always the case, and occasionally the opposite happens. It is only by continuous use over a period of weeks that the benefits of the instrument become apparent.

Nevertheless, I have found during the summer that at any time when a small belt of Calanus has been found, with the surrounding waters devoid of feed, a superior catch has always been the result of shooting in the feed. Naturally, one cannot expect this to happen very often, and when Calanus is very widespread choice of position for fishing is unnecessary unless, as sometimes happens, there are also patches of unfavourable plankton about, when the Indicator can be used in its second capacity.

As an illustration of this I can quote from my own experience on Monday, July 10, of last year. On this day, steering north by east from Rattray Point, we found Calanus fairly good from 30 miles onward to 50 miles, but although each disc we towed was seemingly good enough to shoot on, I noticed that every one was clogged with a fine, jelly-like substance. Continuing on our course, at 54 miles we obtained a good disc of Calanus which was also quite free from the jelly; in fact, the remarkable liveliness of the Calanus here was noticeable after their lifeless condition when amongst the jelly on the earlier discs.

Thus, although we had found good feed for over 20 miles, there was also the unfavourable organism present until we were 54 miles from Rattray. We shot exactly where we had towed this good disc, and our catch of 70 crans next morning was well above the average at Peterhead or Fraserburgh.

I have also found that when there is no Calanus about but only wide patches of weedy or unfavourable water, the same procedure of steaming until clean water is found usually has a beneficial result. . . .

From May 1 to July 30 we shot 69 times—40 shots were in water with little or no Calanus, and the average catch for these was 3 crans; 29 shots were in water containing good or fairly good Calanus, and the average for these 29 shots was 9.5 crans. Thus, when Calanus was present there was an increase of 216 per cent in the average catch."

Mr. H. K. George, master of the S.D. *Ocean Spray*, YH 264, also wrote in *The Fishing News* (June 16th, 1934) as follows :

"I feel sure that other skippers amongst your readers will be interested in hearing of further practical results obtained with the Indicator, as if properly worked and studied it will greatly assist a skipper in finding the best fishing grounds in the spring and summer fishing. As examples I will quote two instances which stand out vividly in my mind.

Herrings were very scarce and dear at Shields on this particular day, and the only boat to have any was the motor boat *Twilight* with 12 crans from N.E. by N. 20 miles, so that was where we started for that day. After we had steamed 8 miles I put the Indicator over and pulled it up every mile until we were 13 miles without seeing the slightest signs of Calanus.

Between 13 and 14 miles there were a few on the disc; from 14 to 15 miles it was a very good disc; from 15 to 16 miles it was only moderate again, and from then on to where the *Twilight* was shooting her nets at 20 miles there was nothing on the disc, so we steamed back to where we found the Calanus, and we found it again.

We shot our nets and got 16 crans of herrings, which was a good night's work, and not one of the other boats got any, they all being three miles and more to the north of us.

The next instance was one day we had 40 crans from 22 miles E.N.E., and steaming

off that day I put the Indicator over and the best disc I got was between 17 and 18 miles, but I carried on the 22 miles and could not find any *Calanus*, so I steamed back to where I got the good disc and found it again.

The same thing happened as before, and with that and many other instances when it happened it gave me complete confidence, though I don't pretend to think it is infallible, as at times we have found feed and got very few herrings, and at others we have not found any feed and yet we have got a few herrings, though not many.

I also noticed that the week when herrings were plentiful at Shields, the sea where the herrings were full of *Calanus*, but it didn't last long in so widespread a nature, neither did the herrings. I have had several chats with other skippers who I know take a great interest in this work, and I am sure we were unanimous on the point that the skipper who has an Indicator and takes interest in it will be streets ahead of them who just trust to pot luck.

Some of the older skippers don't believe in it, though I think in a very short time they will have to admit."

Our experiments in the summer fishery ended in 1933 so that we have no data for the Shields fishery in 1934. This is unfortunate because conditions during the 1934 season at Shields do not appear to have been favourable to the use of the Indicator. Whilst we have no statistical evidence from the analysis of samples, the skippers using the Indicator have told me that they were not able to get the same advantage from it as in the previous year. In the summer of 1935, however, Mr. Balls obtained more samples for us which showed an average gain in the richer *Calanus* water of 23.4%; the details of these samples are given as a postscript to Part II on p. 240. Some further samples were also obtained from the Scottish fishery in 1935 and the results of these correlations are appended to Part III.

CONFIRMATION OF RESULTS.

The results obtained from the material by Mr. Lucas for the English fisheries and Dr. Henderson for the Scottish fisheries are mutually confirmatory in regard both to the positive *Calanus* and the negative phytoplankton correlations. A preliminary account of these *Calanus* results was first published in the *Fish Trades Gazette*, May 12th, 1934, and further confirmation has recently been obtained from Iceland. Mr. Fridriksson of the Fisheries Department at Reykjavik kindly arranged to carry out experiments with the standard Plankton Indicator in relation to the herring in Icelandic waters. He has recently (Fridriksson, 1935) reported on the results of his experiments and the following is quoted from his English summary: ". . . we can clearly see a positive relation between the maximum catches [of herring] and the maximum numbers of *Calanus finmarchicus*. On the other hand we can find no pronounced relation between the catch . . . and the two frequent plankton copepods *Acartia* and *Temora*. . . No relation can be found, neither positive nor negative, between the number of *Sagitta* and the amount of the catches."

ACKNOWLEDGEMENTS.

In carrying out these researches we have been dependent upon the kind help of a very large number of people. We wished to make the experiment as representative as we could of conditions in the fishery and to this end it was desirable to enlist the co-operation of as many skippers of drifters as possible. At one time and another, for varying periods, thirty-five drifters have taken part and it has been a source of great encouragement to us to know how keenly interested most of the skippers have been in the progress of the work. It is not always easy for the practical fisherman to give the necessary time to such work, especially in the trying conditions of rough weather. We extend to them our warmest thanks and appreciation for this great help and to a number of them for the kind hospitality shown to us when we have accompanied them on their voyages. A list is given below of the skippers who took part in the work.

We are equally indebted to the Commanding Officers of the gunboats of the Mine Sweeping and Fishery Protection Flotilla: H.M.S. *Boyne* (Lieut.-Com. S. A. Brooks, R.N.), H.M.S. *Cherwell* (Lieut.-Com. H. R. Gordon-Cumming, R.N.), H.M.S. *Dee* (1930; Lieut.-Com. W. V. H. Harris, R.N., M.V.O., D.S.C. and Lieut.-Com. C. K. Adam, R.N., 1931-33; Lieut.-Com. S. A. Brooks, R.N. 1933; Lieut.-Com. W. Walmsley, R.N.) and H.M.S. *Foyle* (Lieut.-Com. R. Dalby, R.N.); to the Commander and Officers of the Fishery Cruisers *Minna*, *Norma* and *Freya* belonging to the Fishery Board for Scotland and to the Research Vessel *City of Edinburgh* (Skipper John Munro) of the Department of Scientific and Industrial Research, all of whom have taken numerous samples alongside drifters fishing; to the Fishery Officers and Collectors of the Ministry of Agriculture and Fisheries and the Fishery Board for Scotland, who have rendered us every assistance at the different ports in the collection of Indicator discs and data; to the Humber Pilot Steam Cutter Co. Ltd. for allowing us to carry out tests with instruments on their ships and to members of the firm of Messrs. Bloomfield's Ltd. who have given us special facilities both in the placing of instruments on their drifters and providing working accommodation at Lerwick and Yarmouth. To all these gentlemen we extend our most grateful thanks.

We are also most grateful to Professor R. A. Fisher, F.R.S., for kindly examining the methods used in making the correlations and for suggesting the working out of the Standard Errors given in Parts II, III and IV.

This investigation has been made possible by grants from the College and the Treasury on the recommendation of the Development Commissioners, and in addition the Leverhulme Trustees, the Hull Fishing

Vessel Owners Association and the Fishmonger's Company have contributed funds to the development of the wider, but associated, plankton survey by means of recorders.

The Council of the Royal Society has graciously made a grant of £80 towards the cost of publishing the results.

Masters and their Steam Drifters taking part in the experiment.

- F. E. Aldred : *Territorial LT 339.*
 L. Balls : *Emulate YH 349, Ocean Retriever YH 307.*
 R. Balls : *Violet and Rose YH 757, Golden Spray YH 97.*
 D. Brown : *Ocean Crest YH 876.*
 E. Brown : *Ocean Rambler YH 725.*
 R. Brown : *D'Arcy Cooper YH 370.*
 E. G. Catchpole : *Repay LT 273.*
 L. Claxton : *Tessie YH 769.*
 J. Condon : *Ocean Vim YH 88.*
 S. Corey : *Ocean Trust YH 160.*
 A. Cowie : *Poseidon BCK 157.*
 S. Cumby : *Ocean Guide YH 24.*
 A. Dawkins : *Ocean Pilot YH 325.*
 L. Dawkins : *Ocean Sunlight YH 28.*
 N. Garrod : *Effort LT 1043.*
 H. K. George : *Ocean Spray YH 264.*
 J. C. George : *Golden Gain YH 91.*
 J. George : *Ocean Treasure YH 574.*
 L. George : *Ocean Pioneer YH 189, Ocean Reward YH 730, Ocean Toiler YH 312.*
 B. Hall : *Ocean Crest YH 876.*
 B. Haylett : *Ocean Gain YH 184, Ocean Treasure YH 574.*
 A. Larnier : *Hilda Cooper YH 392.*
 J. Lawn : *Ocean Dawn YH 47.*
 J. More : *Mayberry WK 79.*
 R. W. Nunn : *Ocean Lux YH 84.*
 S. Roper : *Ocean Pioneer YH 189.*
 A. Sago : *Boy Alan LT 331*
 P. H. Smith : *Ocean Trust YH 160.*
 R. C. Stubbs : *New Spray YH 135, Togo YH 248.*
 — Tungate : *Emulate YH 349.*
 — Turrell : *Girl Margaret LT 420.*
 K. Thompson : *Ocean Lifebuoy YH 29.*

REFERENCES.

- BROOK, G. 1886. Report on the Herring Fishery of Loch Fyne and the adjacent districts, 1885. Fourth Annual Report, Fishery Board for Scotland, 1885.
- BULLEN, G. E. 1908. Plankton Studies in Relation to the Western Mackerel Fishery. Journ. Mar. Biol. Assoc., N.S., Vol. VIII, p. 269.
- CALDERWOOD, W. L. 1895. The Feeding Ground of the Herring. *Nature*, Vol. LIII, p. 54.
- FRIDRIKSSON, A. 1935. Fiskirannsóknir, Fiskifélago Islands, IV, pp. 50, 67. Reykjavik.
- GARDINER, A. C. 1933. Vertical distribution in *Calanus finmarchicus*. Journ. Mar. Biol. Assoc., N.S., Vol. XVIII, pp. 575-610.
- GOODSIR, H. D. S. 1843. Account of the Mairde of the Fishermen. Edinburgh New Philosophical Journ., Vol. XXXV, p. 102.
- GUNTHER, E. R. 1934. Observations on the Fatty Constituents of Marine Plankton. Part 1. Biology of the Plankton. Journ. Exp. Biol., Vol. XI (2), pp. 173-197.
- HARDY, A. C. 1923. Notes on the Atlantic Plankton taken off the East Coast of England in 1921 and 1922. Publication de Circonstance No. 78, Copenhagen.
- 1924. Report on the Food and Feeding Habits of the Herring. Min. of Agric. and Fisheries. Fish. Invest., Ser. 11, VII, No. 3.
- 1926. The Herring in relation to its animate environment, Part II. Report on trials with the Plankton Indicator. *Ibid.*, VIII, No. 7.
- 1930. Science and the Fishing Industry. Hull.
- HENSEN, V. 1893. Bericht der Kommission zur wissenschaft. Untersuchung der deutschen Meere im Kiel, XVII-XXI, p. 107.
- HERDMAN, W. A. and RIDDELL, W. 1913. The Plankton on the West Coast of Scotland in relation to that of the Irish Sea. Part III. (Report for 1912, Lancashire Sea Fisheries Laboratory.) Trans. Liverpool Biol. Soc., Vol. XXVII, p. 368.
- LUCAS, C. E. and HENDERSON, G. T. D. 1936. On the association of jellyfish and other organisms with catches of herring. Journ. Mar. Biol. Assoc., N.S. Vol. XXI, pp. 293-304.
- MARSHALL, S. M., NICHOLLS, A. G. and ORR, A. P. 1934. On the Biology of *Calanus finmarchicus*. V. Seasonal Distribution, Size, Weight, and Chemical composition in Loch Striven in 1933, and the relation to the Phytoplankton. Journ. Mar. Biol. Assoc., N.S., Vol. XIX, pp. 793-827.

- NICHOLLS, A. G. 1933. On the Biology of *Calanus finmarchicus*. III. Vertical Distribution and Diurnal Migration in the Clyde sea area. *Ibid.*, Vol. XIX, pp. 139-64.
- PAULSEN, O. 1906. Studies in the Biology of *Calanus finmarchicus* in the waters round Iceland. Meddelelser fra Kommissionen for Havundersogelser. Serie Plankton, I.
- PEARCEY, F. G. 1885. Investigations on the Movements and Food of the Herring and additions to the Marine Fauna of the Shetland Islands. Proc. Roy. Soc. Edin., Vol. VIII.
- RUSSELL, F. S. 1928. The Vertical Distribution of Marine Macroplankton. VII. Observations on the behaviour of *Calanus finmarchicus*. Journ. Mar. Biol. Assoc., N.S., Vol. XV, pp. 429-454.